



Lithium Coin Cell - CR 2450 V3

- Low self-discharge
- Long shelf life
- UN 38.3 tested
- Wide assortment of mounting options and wire terminals available



RoHS compliant



Pb free



REACH compliant



Conflict mineral free

SPECIFICATIONS	
Jauch part number	247288
Nominal Voltage	3V
Nominal Capacity	610 mAh
Standard Load	7.5 kΩ
Standard Current	0.4 mA
Max. Continuous Current	4 mA
Max. Pulse Current	15 mA
Operating Temperature	-30°C to +85°C *
Weight	Approx. 6.7 g
Chemistry	Li/MnO ₂

Note: Capacity 610mAh is obtained at standard cc load to 2.0V at 23°C.

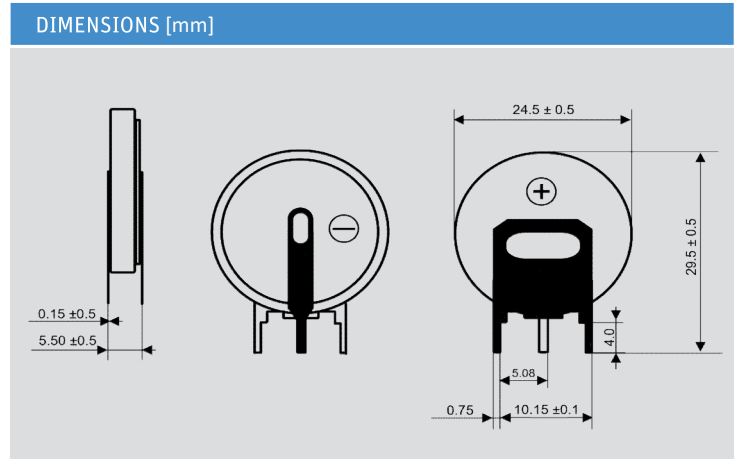

* In applications where the battery is exposed to temperatures >60°C, please contact Jauch.

