



actual size

Oscillator JO22 · 3.3 V

- SMD Oscillator with Stop Function · 2.5 x 2.0 mm
- LVCMOS / HCMOS compatible output
- Low phase jitter, no PLL
- Flat seam sealed ceramic/metal package



RoHS compliant



Pb free



REACH compliant



Conflict mineral free

GENERAL DATA		JO22 3.3 V
TYPE	JO22 3.3 V	
frequency range	0.75 ~ 50.0 MHz	
frequency stability over all*	± 25 ppm ~ ± 100 ppm see table 1	
current consumption	see table 2	
supply voltage V_{DC}	3.3 V ± 10% (± 5% for stab. C)	
temperature	operating	-20 °C ~ +70 °C up to -40 °C ~ +125 °C
	storage	-55 °C ~ +125 °C
output	rise & fall time	see table 3
	load max.	15 pF
	current max.	4.0 mA
	low level max.	0.4 V
	high level min.	$V_{DC} - 0.4$ V
output enable time max.	10 ms	
output disable time max.	50 µs	
start-up time max.	10 ms	
standby function	stop	
standby current max.	10 µA / 20 µA for T2, T3	
phase jitter 12 kHz ~ 20.0 MHz	< 1.0 ps RMS	
symmetry at 0.5 x V_{DC}	45% ~ 55% max.	

* includes stability at 25 °C, operating temp. range, supply voltage change, shock and vibration, aging 1st year.

TABLE 1: FREQUENCY STABILITY CODE					
stability code		A	B	G	C
		± 100 ppm	± 50 ppm	± 30 ppm	± 25 ppm
-20 °C ~ +70 °C			○	○	○
-40 °C ~ +85 °C	T1	○	○	○	
-40 °C ~ +105 °C	T2	○	○		
-40 °C ~ +125 °C	T3	○			

○ available

TABLE 2: CURRENT CONSUMPTION MAX.	
3.3 V: current at 15pF load:	
0.75 ~ 19.9 MHz	6 mA
20.00 ~ 39.9 MHz	7 mA
40.00 ~ 50.0 MHz	8 mA

TABLE 3: RISE & FALL TIME MAX.	
5 ns: 0.75 ~ 50.0 MHz	note: - specific data on request - rise time: 0.1 V_{DC} ~ 0.9 V_{DC} - fall time: 0.9 V_{DC} ~ 0.1 V_{DC}

DIMENSIONS

top view side view bottom view pad layout pin connection in mm

1: e/d
2: ground
3: output
4: V_{DC}

ORDER INFORMATION

0	frequency	type	frequency stability code	supply voltage code	output load code	option
Oscillator	0.75 ~ 50.0 MHz	JO22	see table 1	3.3 = 3.3 V	1 = 15 pF	blank = -20 °C ~ +70 °C T1 = -40 °C ~ +85 °C T2 = -40 °C ~ +105 °C T3 = -40 °C ~ +125 °C

Example: 0 20.0-JO22-B-3.3-1-T1-LF (Suffix LF = RoHS compliant / Pb free)

Oscillator J022 · 3.3 V · Stop Function

TAPING SPECIFICATION

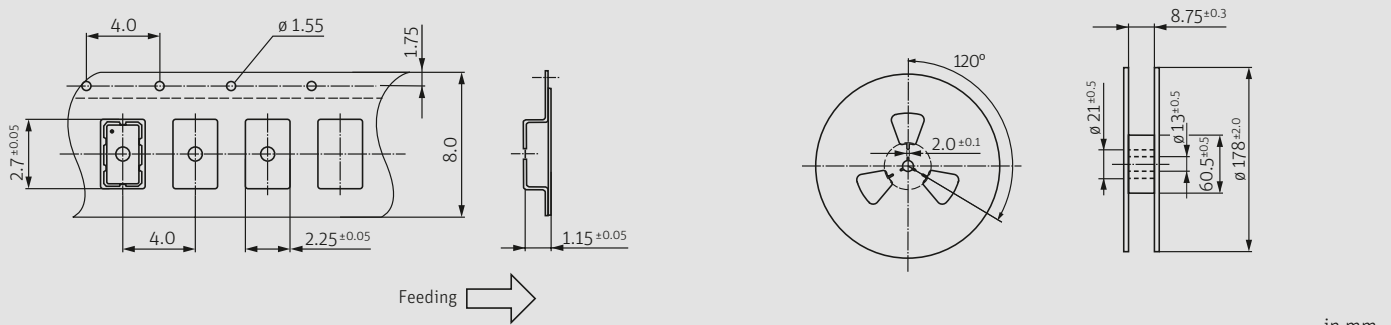

ENABLE / DISABLE FUNCTION

pin #1 (e/d control)	pin #3 (output)
open	active
high "1" ($V_{IH} \geq 0.8 V_{DC}$)	active
low "0" ($V_{IL} \leq 0.2 V_{DC}$)	high impedance

stop function:

- oscillator stops
- output high impedance

MARKING

frequency

company stability code / date code

date code: A ~ M: Jan. - Dec.

0: 2020 1: 2021 2: 2022 3: 2023 4: 2024 5: 2025

Jan.	Febr.	Mar.	Apr.	May	June
A	B	C	D	E	F
July	Aug.	Sept.	Oct.	Nov.	Dec.
G	H	J	K	L	M

REFLOW SOLDERING PROFILE

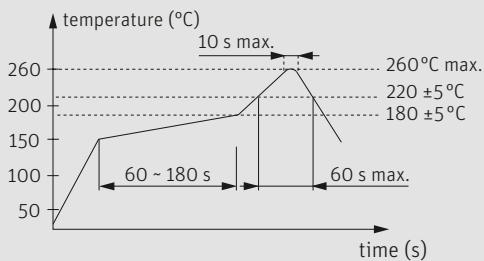

note: parts are also suitable for soldering systems with lead (Pb) content

PACKAGING NOTE

- standard packing unit is 500 pieces per reel
- customized quantities on request

* hand soldering temperature should not exceed 280 °C